

ELEVÉ Quick Install Guide

COMFORT

Preparation

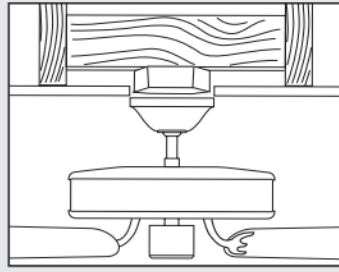
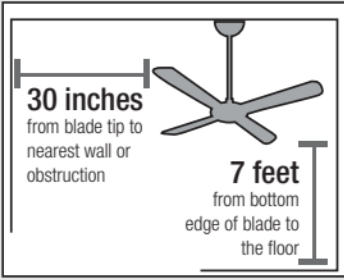

You must be able to secure the fan to building structure or fan-rated outlet box.

Here are the tools you'll need to complete your installation:

Ladder Screwdriver Pliers Wire Strippers

OPTIONAL
If mounting to a support structure, you will also need these tools.

Drill 9/64" Drill Bit

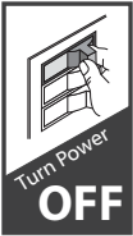

WARNING
To avoid possible electrical shock, before installing your fan, disconnect the power by turning off the circuit breakers to the outlet box associated with the wall switch location.

Assembly Instructions

STEP 1 **OPTION 1: Machine Screws**
Use machine screws (provided with outlet box) and washers when securing to existing ceiling fan-rated outlet box. Make sure it is securely installed and is acceptable for fan support of 31.8 kg (70 lbs).

OPTION 2: Wood Screws
Use wood screws and washers (included) when securing to support structure with approved electrical outlet box. Drill 9/64" pilot holes in support structure to aid in securing ceiling bracket with hardware found in the ★ hardware bag.

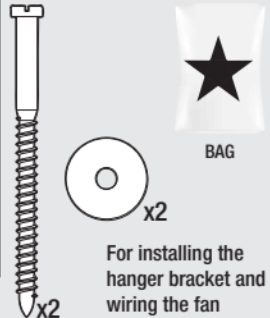
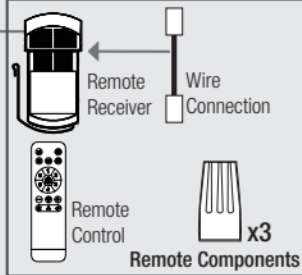
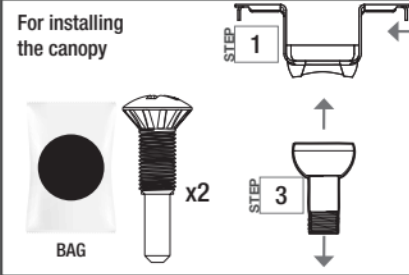

WARNING
FAN FALL HAZARD
To prevent **SERIOUS INJURY** or **DEATH**:

- ALWAYS tighten setscrew with pliers.
- DO NOT hand tighten setscrew.
- CHECK the setscrew is tight using pliers each time you change fan direction.

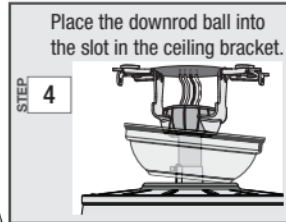
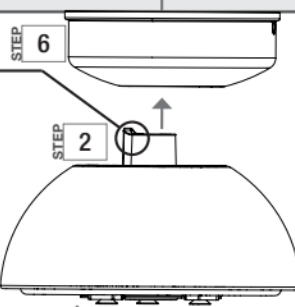

STEP 5 See back for wiring

NOTICE
To prevent damage to fan, ALWAYS lift holding either the fan housing or the downrod.

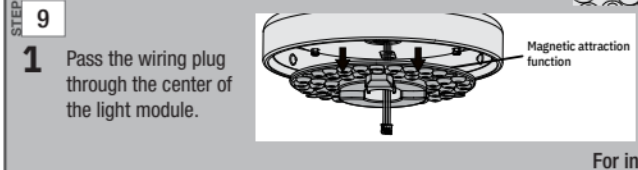
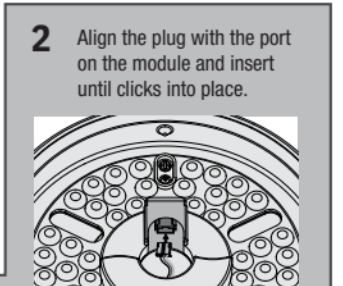
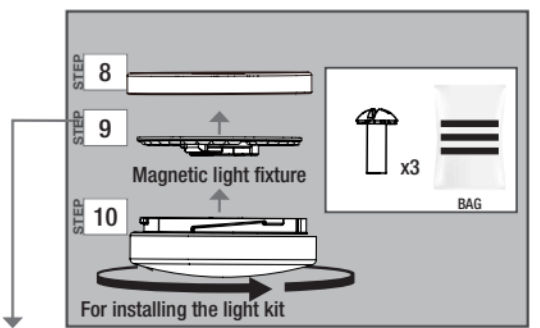
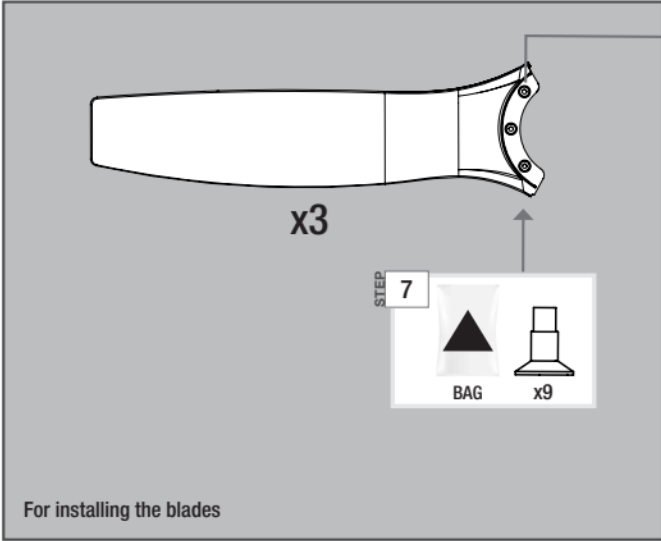

WARNING
GLOBE FALL HAZARD
To prevent **SERIOUS INJURY**, make sure that globe is properly secured.

For installing the LED light

Wiring Instructions

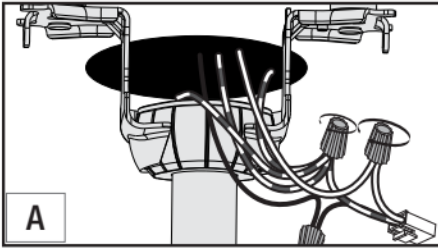

1. Connect the four grounding wires (green, green/yellow stripe, or bare copper) coming from the ceiling wiring harness, downrod and hanging bracket.
2. Connect the white (grounded) wire from the ceiling to the white wire from the wiring harness.
3. Connect the black (ungrounded) wire from the ceiling to the black wire from the wiring harness.

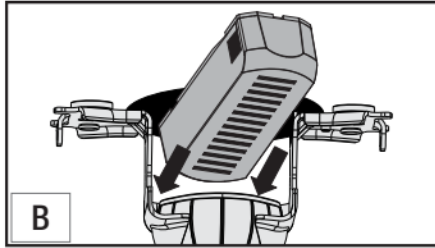

Slide Receiver into bracket.

Note: To connect the wires, hold the bare metal leads together and place a wire connector over them, then twist clockwise until tight. Turn the splices upward and push them carefully back through the hanger bracket into the outlet box. Spread the wires apart, with the grounded wires on one side of the outlet box and the ungrounded wires on the other side of the outlet box.

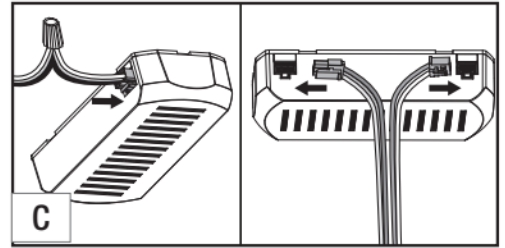

Plug wiring harness and both wiring plugs from fan into the receiver.

⚠ WARNING

All wiring must be in accordance with national and local electrical codes ANSI/NFPA 70. If you are unfamiliar with wiring or in doubt, consult a qualified electrician. The ceiling fan must be grounded. If the ground wire for the installation site is not present, immediately **STOP** installation and consult a qualified electrician.

Preparing the Remote and Cradle

Install two AAA batteries, found in the remote control hardware bag, into the transmitter. Clean the battery contacts prior to installing the batteries. Please contact your local battery recycling center for proper battery disposal information.

The remote control is already paired for use. For your convenience a remote function card is packed in with your remote.

Remote Function Guide

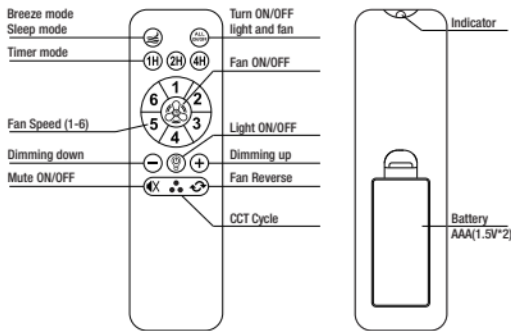

Remote pairing:

1. Turn off the power for 10 seconds.
2. Turn on the power and press the All ON/OFF button immediately within 3s.
3. When hearing 2 sounds like "did", you can free your hands.

ALL ON/OFF:

- Single press the All ON/OFF button, all functions will be turned off and single press the All ON/OFF button again to revert back to previous setting.

Breeze mode:

1. Single Press Breeze Mode/Sleep Mode button. Beep twice to indicate input accepted.
2. Cycle between all speeds at random. Hold each speed for random duration between 20-30 seconds.
3. Stay in mode until cancel condition met: All On/Off, Fan On/Off, Fan speed selected and Reversing.

Sleep mode:

1. Double Press Breeze Mode/Sleep Mode button.
2. Change to lowest dimming setting & lowest fan speed and mute beep.
3. Stay in mode until cancel condition met: All On/Off, Light On/Off, Light Dimming Up/Down.

CCT Cycle:

- Press the CCT Cycle button, the light will cycle within 3 different color temperature. When power-on again, the light will memory the last setting.

Mute ON/OFF:

- Press Mute ON/OFF button to turn on or off with a beep feedback.

Timer:

- Press 1H or 2H or 4H to trigger the timer function and press any non-timing key to cancel the timer.



Troubleshooting

Fan Doesn't Work

- Make sure power switch is on.
- Check the circuit breaker to ensure the power is turned on.
- Make sure the blades spin freely.
- Turn off power from the circuit breaker, then loosen the canopy and check all the connections according to the wiring diagram.
- Check the plug connections on the receiver in the canopy.

Excessive Wobbling

- Make sure the blades are properly installed on the blade iron posts.
- Turn the power off, support the fan carefully, and check that the hanger ball is properly seated.

Noisy Operation

- Make sure the blades are properly installed.
- Check to see if any of the blades are cracked. If so, replace all of the blades.

Down Rod

If you need a different downrod length follow these steps:

Follow steps 1-5 to remove standard downrod pipe

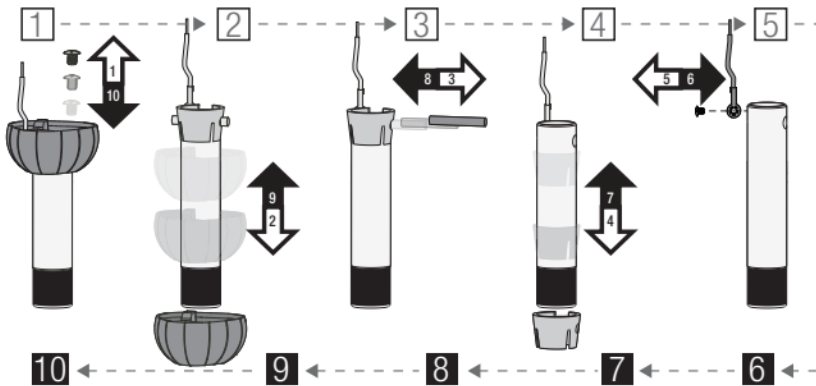

Follow steps 6-10 to reassemble with new downrod

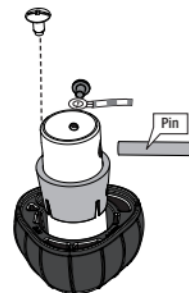

Here is another view of the downrod assembly unassembled.

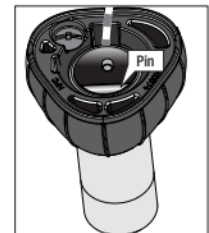

Assembled downrod should look like this

⚠ WARNING

FAN FALL HAZARD
To prevent SERIOUS INJURY or DEATH:

- ALWAYS follow the downrod assembly instructions exactly.
- VERIFY the downrod is assembled correctly by firmly pulling on the hanger ball.
- Pin must be reinserted to secure downrod assembly.



Note: Product is limited to a 12" downrod