



Downtown

Installation Manual

Model: 51589 Matte Silver
51590 Flat Matte Black
53436 Matte White
Fan weight ± 2 lbs: 22.0 lbs (10.0 kg)



3D INTERActive GUIDE

Step 1: Scan QR code with smart phone or tablet

Step 2: Follow on screen instructions

Step 3: Register your product



Our digital guided installation takes you seamlessly from unboxing to completion with clear instructions and visual aids. With the convenience of accessing the guide on your smartphone, tablet, or computer, you can take your installation experience wherever you go.

The ceiling fan you purchased will provide comfort and performance in your home or office for many years. This instruction manual contains complete instructions for installing and operating your fan. We are proud of our work and appreciate the opportunity to supply you with the best ceiling fan available anywhere in the world. This Instruction Manual is designed to make installation as simple as possible. If you are unfamiliar or uncomfortable with wiring, contact a qualified electrician. We also provide telephone support at 1.888.830.1326 or visit us at HunterFan.com.

REGISTER TODAY! FREE Limited Lifetime Warranty

To activate your free limited lifetime warranty, please scan the QR code and register your product. This will ensure you receive exceptional service and support for years to come.



SCAN ME

! WARNING



READ and SAVE These Instructions

Warning

w.1 - To reduce the risk of fire, electrical shock, or personal injury, mount fan directly from building structure and/or an outlet box marked acceptable for fan support of 70 lbs (31.8 kg) and use the mounting screws provided with the outlet box.

w.2 - To avoid possible electrical shock, before installing or servicing your fan, disconnect the power by turning off the circuit breakers to the outlet box and associated wall switch location. If you cannot lock the circuit breakers in the off position, securely fasten a prominent warning device, such as a tag, to the service panel.

w.3 - To reduce the risk of electric shock, this fan must be installed with an isolating wall control/switch.

w.4 - To reduce the risk of personal injury, do not bend the blade brackets when installing the blade brackets, balancing the blades, or cleaning the fan. Do not insert foreign objects in between rotating fan blades.

w.5 - This appliance can be used by children aged from 8 years and above and persons with reduced physical, sensory or mental capabilities or lack of experience and knowledge if they have been given supervision or instruction concerning use of the appliance in a safe way and understand the hazards involved. Children shall not play with the appliance. Cleaning and user maintenance shall not be made by children without supervision. It is recommended that children be supervised to ensure that they are not using the appliance improperly.

w.6 - To reduce the risk of fire or electric shock or injury to persons, do not use replacement parts that have not been recommended by the manufacturer (e.g. parts made at home using a 3D printer).

Caution

c.1 - All wiring must be in accordance with national and local electrical codes ANSI/NFPA 70. If you are unfamiliar with wiring, use a qualified electrician.

c.2 - Use only Hunter replacement parts.

This product conforms to UL Standard 507.



Here are the tools you'll need to complete your installation:



Ladder

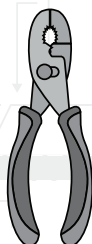

Pliers



Screwdriver



Wire Strippers

OPTIONAL

If mounting to a support structure, you will also need these tools.

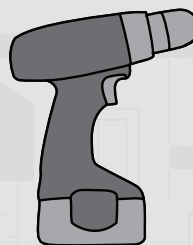

Drill

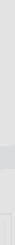

9/64" Drill Bit

Here is what comes in your box:

We recommend that you pull everything out of the box and lay it out. We have grouped the drawn components below with the hardware you'll need for those parts. The screws below are drawn to scale to make it easier to identify what piece of hardware is needed to install each component.

Hunter Pro Tip:

Do not discard the hardware bags or mix parts from different bags. Make note of the symbol printed on each hardware bag. The symbols can be used to identify the appropriate hardware for each step.

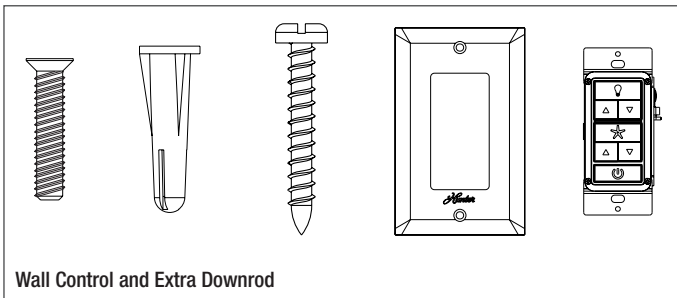
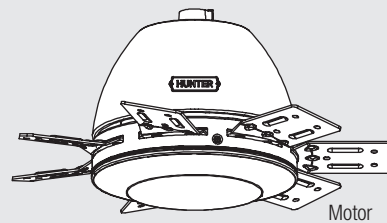
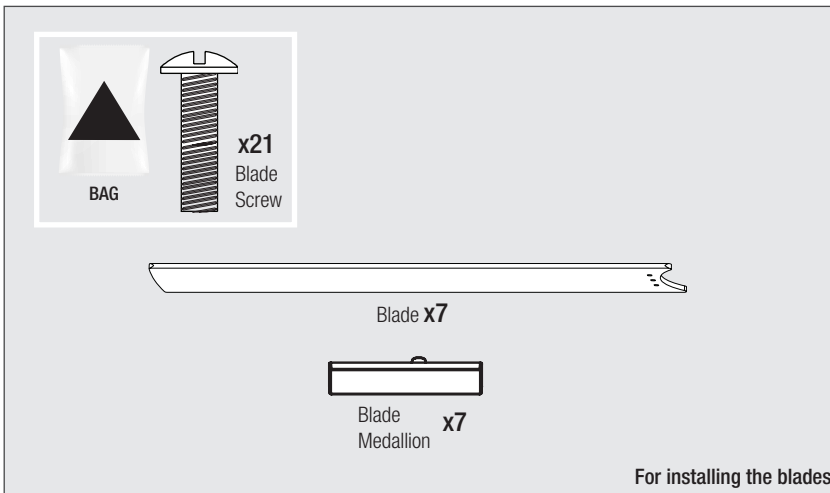
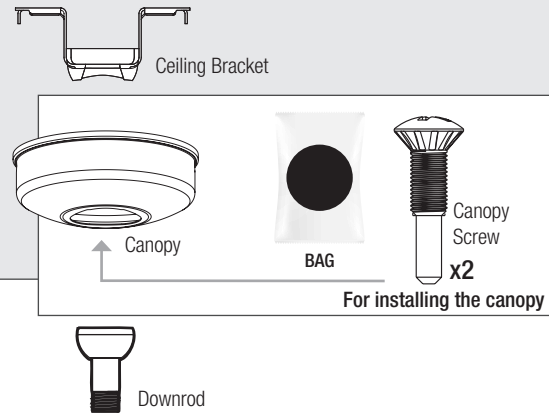
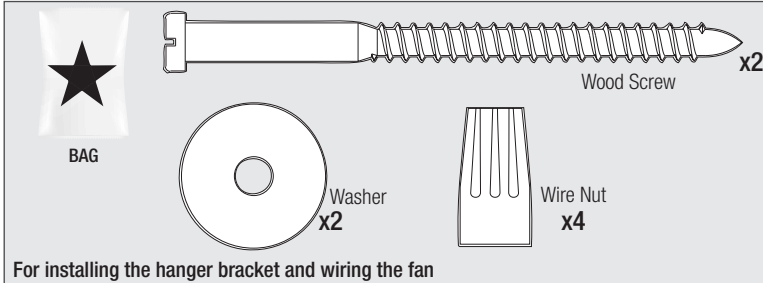

Note:

Fan style may vary.

Find a part that is missing or damaged? Don't take it back to the store. Let us make it right. Visit us at HunterFan.com or call us at 1.888.830.1326.

Choosing the Right Installation Location

You probably bought this fan with a location in mind. Let's check below to make sure it is a good fit.

Check the room dimensions:

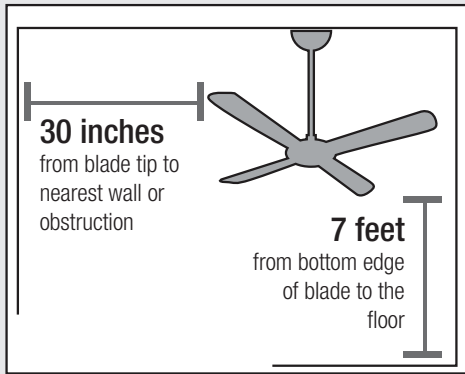

Check the outlet box:



You must be able to secure the fan to building structure or fan-rated outlet box.

Checking the Ceiling Angle:

Standard Mounting



If you have a flat ceiling:

Hang your fan by a standard downrod. Some fans come with a shorter downrod for a Low Profile installation.



If you have an angled or vaulted ceiling:

1. You will need a longer downrod. (sold separately at HunterFan.com)
2. If your ceiling angle is greater than 34°, you will also need an Angled Mounting Kit. (Sold separately at HunterFan.com)

Angled Mounting

A little more information on Angled Mounting:

For optimum performance and appearance, a longer downrod should be used with your Hunter ceiling fan when installing on high or angled ceiling. If your ceiling is angled greater than 34° you will also need an Angled Mounting Kit. Longer downrods and the Angled Mounting Kit are sold separately at HunterFan.com.

Hunter Pro Tip:

Determining if you need an Angled Mounting Kit:

Fold on the dotted line. Place against edge against the wall. Slide towards the ceiling.

If the guide touches the wall but not the ceiling, you need an angled mounting kit.

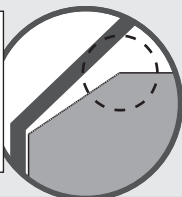

WALL

34°

CEILING

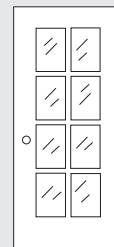
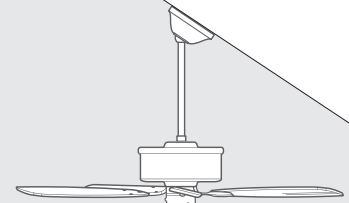

Installing the Ceiling Bracket

You have **two options** for installation. Pick which one works best for your location. Remove any existing bracket prior to installation. **Only use the provided Hunter ceiling bracket that came in your fan's box.**

Hunter Pro Tip:

The machine screws are the ones that came with your outlet box.



Do this first!

WARNING

To avoid possible electrical shock, before installing your fan, disconnect the power by turning off the circuit breakers to the outlet box associated with the wall switch location.

Option 1: Machine Screws

Use machine screws (provided with outlet box) and washers when securing to existing ceiling fan-rated outlet box. Make sure it is securely installed and is acceptable for fan support of 31.8 kg (70 lbs) or less.

ANGLED MOUNTING TIP

For angled ceilings, point opening toward peak.



Option 2: Wood Screws

Use wood screws and washers (included) when securing to support structure with approved electrical outlet box. Drill 9/64" pilot holes in support structure to aid in securing ceiling bracket with hardware found in the ★ hardware bag.

Washer x2

★ BAG

Wood Screw x2

Installing the Downrod

Follow below if you are using the downrod that came pre-assembled in your box. Need to install a longer or shorter downrod? Check out the guide at the end of this manual.

Hunter Pro Tip:

The ground wire attached to the downrod is approximately 8 inches.

STEP 1

Remove the pre-installed setscrew so that the downrod can be inserted.

KEEP!

STEP 2

3/8"

8" (not to scale)

CUT

STRIP

Pass all wires to one side of horizontal bar in downrod assembly. Hand tighten the downrod (at least 4-5 full turns) until it stops. Trim the wires coming from the fan so that 8-inches remain coming from the top of the downrod.

STEP 3

Tighten the setscrew with pliers. **DO NOT HAND TIGHTEN.**

WARNING

FAN FALL HAZARD

To prevent **SERIOUS INJURY** or **DEATH**:

- ALWAYS tighten setscrew with pliers.
- DO NOT hand tighten setscrew.
- CHECK the setscrew is tight using pliers each time you change fan direction.

Hanging the Fan

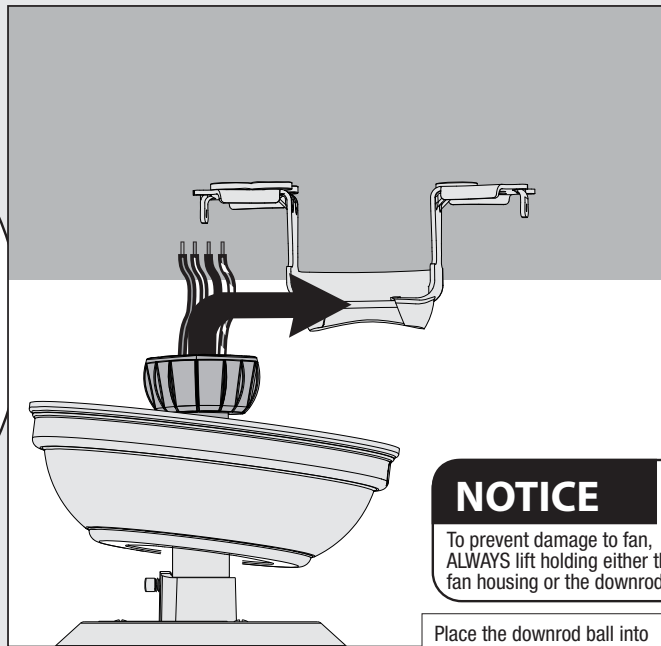
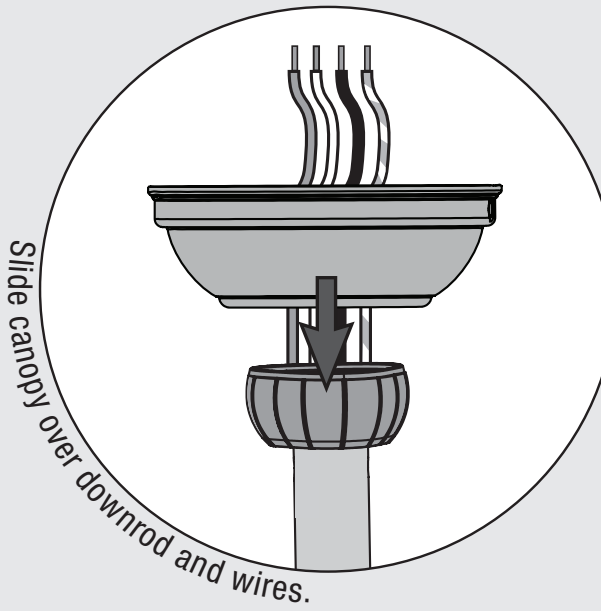

Progress Check:
Your fan should look like this.

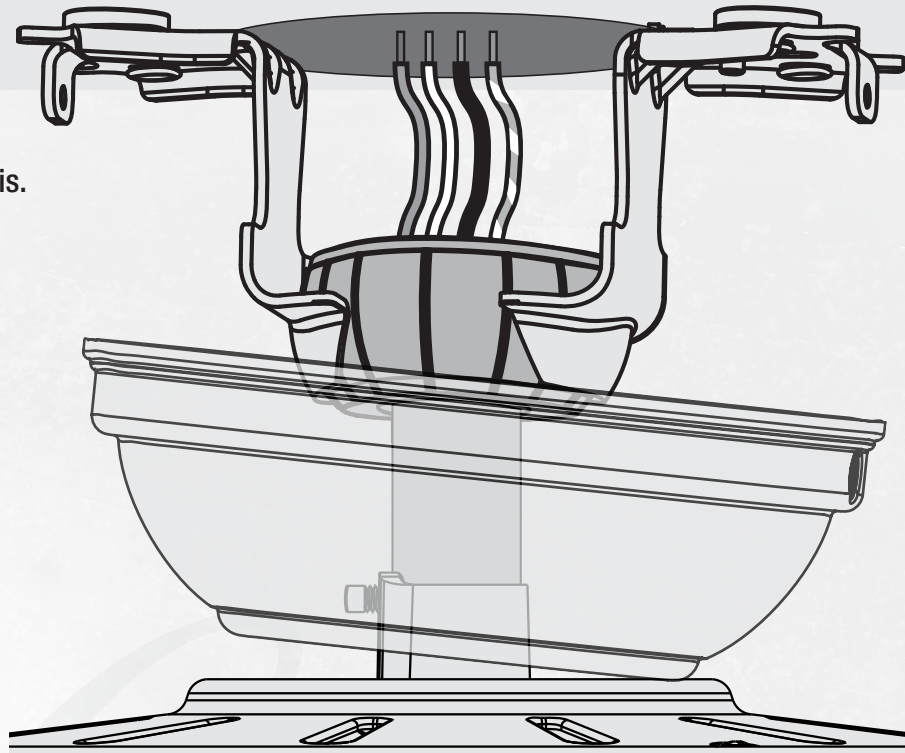

Note:

Fan style may vary.

We know wiring is hard. Let's make it easier.

Follow these steps to get your fan wired quickly and safely. Follow the route below that best matches your wall switch setup. If you are unfamiliar with wiring or uncomfortable doing it yourself, please contact a qualified electrician.

You are going to need these:

4 Wire Nuts (these are in the ★ bag)

Hunter Pro Tip:

Here is how to connect the wires:

Push the bare metal ends of the wires together and slide a wire nut over them. Then, twist the wire nut clockwise until tight. Give it a gentle pull to make sure none of the wires are loose.



Have a single switch?

Follow these steps:

Connect the white (grounded) wire from the ceiling to the white wire from the fan.

Connect the black (ungrounded) wire from the ceiling to the black wire from the fan.

Cap the blue wire from the fan. You will not need it for single switch wiring.

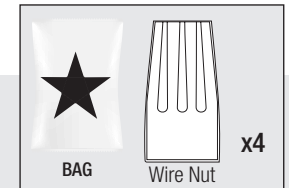

Connect the three grounding wires (green, green/yellow stripe, or bare copper) coming from the ceiling, downrod, and hanging bracket.

⚠ WARNING 
The ceiling fan must be grounded. If the ground wire for the installation site is not present, immediately **STOP** installation and consult a qualified electrician.

⚠ WARNING 
All wiring must be in accordance with national and local electrical codes ANSI/NFPA 70. If you are unfamiliar with wiring or in doubt, consult a qualified electrician.

Hunter Pro Tip:

Have extra wiring?

Turn the wires upward and push them carefully back through the hanger bracket into the outlet box. Spread the wires apart, with the grounded wires on one side of the outlet box and the ungrounded wires on the other side of the outlet box. Make sure that the wires are still attached to the wire nuts.

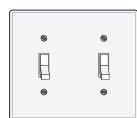

Have dual switches?

Follow these steps:

Connect the white (grounded) wire from the ceiling to the white wire from the fan.

Connect the black (ungrounded) wire from the ceiling to the black wire from the fan.

Connect the second ungrounded (light) wire from the ceiling to the blue wire from the fan.

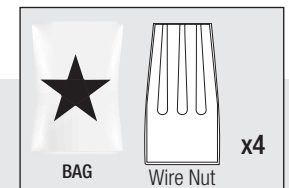

Connect the three grounding wires (green, green/yellow stripe, or bare copper) coming from the ceiling, downrod, and hanging bracket.

Note:

Fan style may vary.



DRSKY-01 r091420

Installing the Canopy

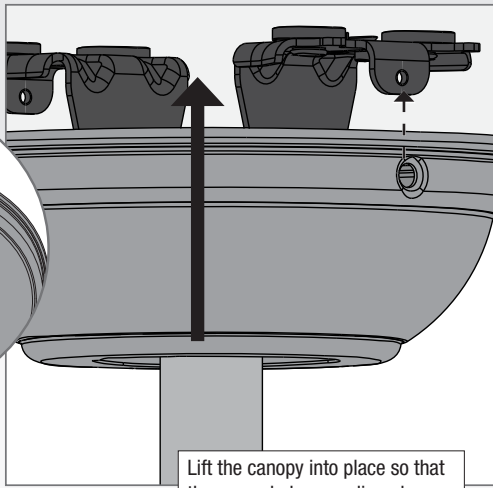

Fit the canopy in place as shown.

Lift the canopy into place so that the screw holes are aligned.

Insert the two canopy screws found in the ● hardware bag.

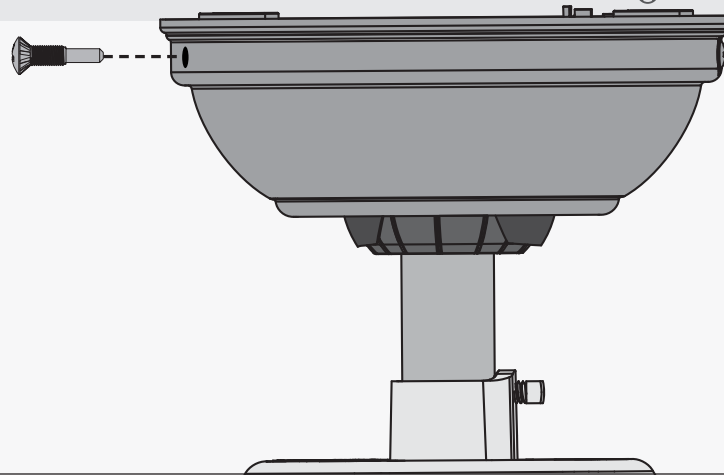
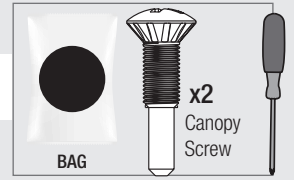

Installing the Blades:

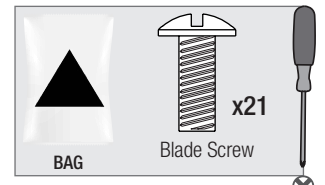
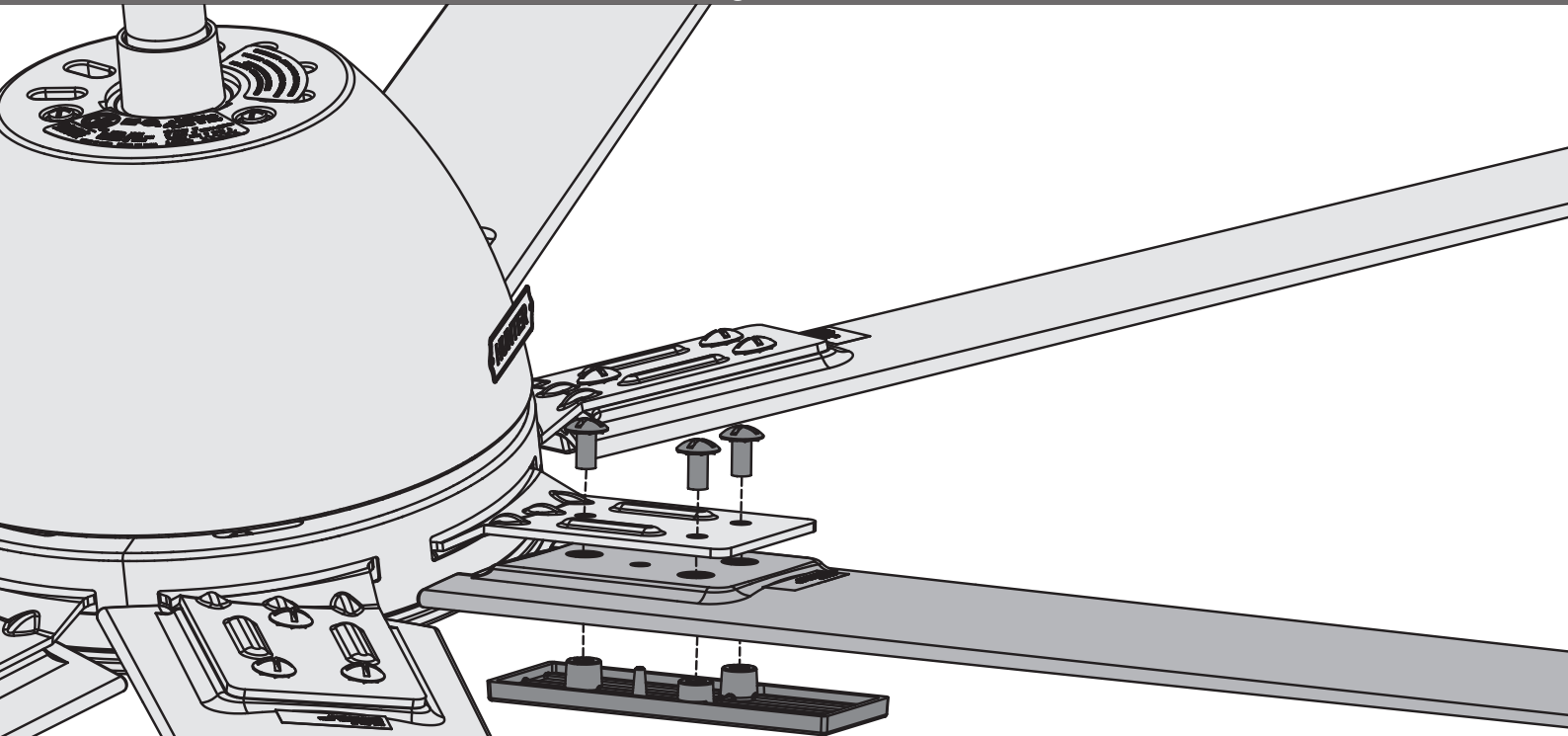

▲ IMPORTANT

NOTE: Follow the instructions on the blade. Installing it incorrectly could result in your fan not functioning.

Note:

Fan style may vary.

Place each blade between a blade iron and medallion. Install three blade screws, found in the ▲ hardware bag, to attach the medallion to the blade iron. Repeat this step for each blade.

Repeat x7

Preparing the Wall Control

- 1** **Turning off the power**
Ensure the power is OFF at the outlet box and wall switch location before proceeding with installation.

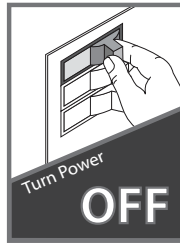

- 2** **Installing the battery**
To access the battery compartment, slide the battery door up.
Replace the used battery with two AAA batteries when needed.

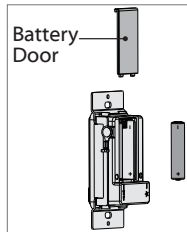

- 3** **Wiring the Wall Control**
Connect the grounding wire from the wall control to the ground control from the switch box using the provided wire nuts.
Connect the "LIVE IN" from the switch box to the "~VAC" from the wall control using the provided wire nuts.
Connect the "LIVE OUT" from the switch box to the "FAN" out from the wall control using the provided wire nuts.
Push all wires into the switch box.

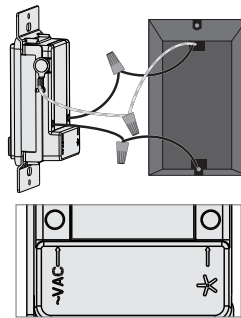

- 4** **Installing the Wall Control**
Install the longer screws through the slots in the wall control into the switch box screw holes.

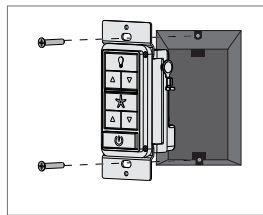

- 5** **Installing the Wall Plate**
Install the shorter screws through the wall control plate and into the screw holes in the wall control.

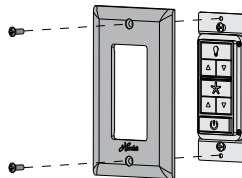

- 6** **Turning on the power**

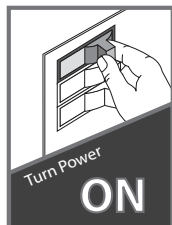

KEY PRESS FUNCTION

LIGHT FUNCTIONS (NOT APPLICABLE)

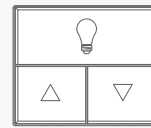

Light On/Off



Light Dimming Control

Long Press 

Light High

Long Press 

Light Low

Long Press 

Dimming Mode On/Off

FAN FUNCTIONS

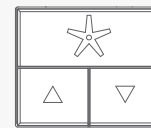

Fan On/Off



Fan Speed Control

Long Press 

Fan High

Long Press 

Fan Low

Long Press 

Reverse



Power On/Off

Long Press  + 

Pair Function

- 7** The remote transmitter is already paired to the receiver and ready to use. If you need to pair your remote, cycle power to the fan by turning power off and back on at the wall switch (or circuit breaker if necessary). Within three minutes, do the following:



- 8** Reference the included remote function card for information on how to use your wall control!

Troubleshooting

Fan Doesn't Work

- Make sure power switch is on.
- Check the circuit breaker to ensure the power is turned on.
- Make sure the blades spin freely.
- Turn off power from the circuit breaker, then loosen the canopy and check all the connections according to the wiring diagram.

Excessive Wobbling

- Make sure the blades are properly installed on the blade iron posts.
- Turn the power off, support the fan carefully, and check that the hanger ball is properly seated.

Noisy Operation

- Make sure the blades are properly installed.
- Check to see if any of the blades are cracked. If so, replace all of the blades.

Hunter Pro Tip:

Cleaning the Fan

Use soft brushes or cloths to prevent scratching. Cleaning products may damage the finishes.

Limited Lifetime Warranty

Hunter Fan Company grants this limited warranty to the original purchaser of this Hunter ceiling fan. This document can be found at www.HunterFan.com. Thank you for choosing Hunter!

How Can Warranty Service Be Obtained?

Proof of purchase is required when requesting warranty service. The original purchaser must present a sales receipt or other document that establishes proof of purchase. Hunter, at its sole discretion, may accept a gift receipt. To obtain service, contact Hunter Fan Company online or by phone.

www.HunterFan.com/Support/Contact-Us/
1-888-830-1326

Please do not ship your fan or any fan parts to Hunter. Delivery will be refused.

What Does This Warranty Cover?

Motor — Limited Lifetime Warranty

If any part of your ceiling fan motor fails during your ownership of the fan due to a defect in material or workmanship, as determined solely by Hunter, Hunter will provide you with a replacement fan free of charge.* The foregoing limited warranty applies only to the motor itself and does not apply to electronic controls – such as remote control transmitters, remote control receivers, or capacitors – used in conjunction with the motor. Such electronic control items are included in the Three-year limited warranty below.

Other — Three-Year Limited Warranty

Except as otherwise indicated throughout this warranty, if any part of your Hunter ceiling fan fails at any time within three years of the date of purchase due to a defect in material or workmanship, as determined solely by Hunter, Hunter will provide a replacement part free of charge.*

** If no replacement product/part can be provided for your fan, we will provide a comparable or superior replacement product/part at the sole discretion of Hunter.*

What Does This Warranty NOT Cover?

Labor Excluded. This warranty does not cover any costs or fees associated with the labor (including electrician's fees) required to install, remove, or replace a fan or any fan parts. There is no warranty for light bulbs; remote control batteries; fans purchased or installed outside the United States; fans owned by someone other than the original purchaser; fans for which proof of purchase has not been established; fans purchased from an unauthorized dealer; ordinary wear and tear; minor cosmetic blemishes; refurbished fans; and fans that are damaged due to any of the following: improper installation, misuse, abuse, improper care, failure to follow Hunter instructions, accidental damage caused by the fan owner or related parties, modifications to the fan, improper or incorrectly performed maintenance or repair, improper voltage supply or power surge, use of improper parts or accessories, failure to provide maintenance to the fan, or acts of God (e.g. flood).

ORIGINAL PURCHASER'S SOLE AND EXCLUSIVE REMEDY FOR A CLAIM OF ANY KIND WITH RESPECT TO THIS PRODUCT SHALL BE THE REMEDIES SET FORTH HEREIN. HUNTER FAN COMPANY IS NOT RESPONSIBLE FOR CONSEQUENTIAL OR INCIDENTAL DAMAGES, DUE TO PRODUCT FAILURE, WHETHER ARISING OUT OF BREACH OF WARRANTY, BREACH OF CONTRACT, OR OTHERWISE. Some States do not allow the exclusion or limitation of incidental or consequential damages, so the above limitation or exclusion may not apply to you.

ANY IMPLIED WARRANTIES OF MERCHANTABILITY OR FITNESS FOR A PARTICULAR PURPOSE APPLICABLE TO THIS PRODUCT ARE LIMITED IN DURATION TO THE PERIOD OF COVERAGE OF THE APPLICABLE LIMITED WARRANTIES SET FORTH ABOVE. Some States do not allow limitations on how long an implied warranty lasts, so the above limitation may not apply to you.

How Does State Law Affect Warranty Coverage?

This warranty gives you specific legal rights. You may also have other rights which vary from state to state.

Downrod

If you need a different downrod length follow these steps:

Follow steps 1-5 to remove standard downrod pipe

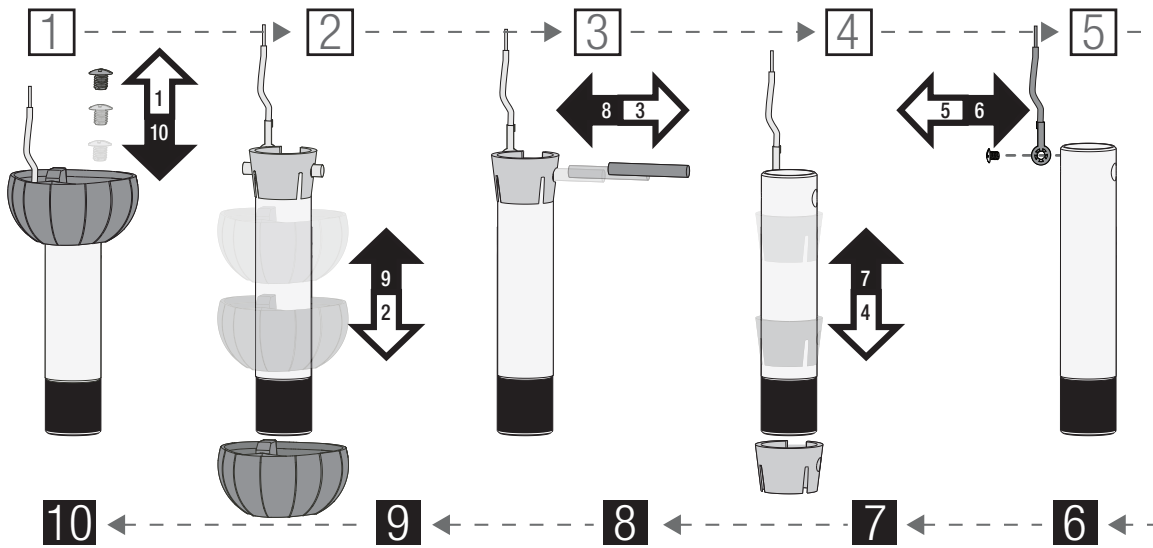

Follow steps 6-10 to reassemble with new downrod

⚠ WARNING

FAN FALL HAZARD

To prevent SERIOUS INJURY or DEATH:

- ALWAYS follow the downrod assembly instructions exactly.
- VERIFY the downrod is assembled correctly by firmly pulling on the hanger ball.
- Pin must be reinserted to secure downrod assembly.

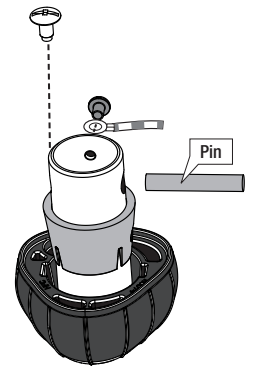

Here is another view of the downrod assembly unassembled.

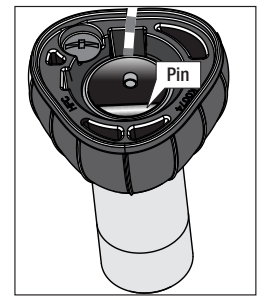

Assembled downrod should look like this